

Series 40 cylinders

Double acting, cushioned, magnetic
 Ø 160 - 200 - 250 - 320 mm



- » In compliance with ISO 15552 standards and with the previous DIN/ISO 6431 - VDMA 24562 standards
- » Adjustable pneumatic cushioning
- » Rolled stainless steel rod (Ø 160 - 200 mm)
- » Chrome plated steel rod (Ø 250 - 320 mm)
- » Rod scraper in brass

Series 40 cylinders have been designed in compliance with ISO 15552 standards and with the previous DIN/ISO 6431 - VDMA 24562 standards.

A permanent magnet on the piston of these cylinders is able to send, through proximity switches mounted on the cylinder sliding axis, electrical signals to indicate its position.

This series is normally equipped with end-stroke cushioning which can be adjusted through a screw on the end block.

In order to quieten the impact of the piston on the end block, these cylinders are also equipped with mechanical cushioning.

GENERAL DATA

Type of construction	with tie-rods
Operation	double-acting
Materials	Coated AL end blocks and piston (Ø250-320 mm), rolled stainless steel AISI 420B (Ø 160-200 mm) or chrome plated steel (Ø250-320 mm) piston rod, zinc-plated steel piston rod nut, anodized AL tube, zinc-plated steel tie-rods and tie-rod nuts, NBR-PU rod - piston and cushion seals, brass rod scraper ring
Mounting	with tie-rods, front flange, rear flange, feet, centre trunnion, front and rear trunnion, swivel combination
Strokes min - max	10 ÷ 2500 mm
Operating temperature	0°C ÷ 80°C (with dry air -20°C)
Operating pressure	1 ÷ 10 bar
Speed	10 ÷ 500 mm/sec (without load)
Fluid	filtered air, without lubrication. If lubricated air is used, it is recommended to use oil ISOVG32. Once applied the lubrication should never be interrupted.

STANDARD STROKES FOR SERIES 40 CYLINDERS

■ = double-acting

∅	25	50	75	80	100	125	150	160	200	250	300	320	400	500
160		■		■	■		■		■		■		■	■
200		■			■				■		■			
250		■			■				■		■			
320		■			■				■		■			

CODING EXAMPLE

40	M	2	L	160	A	0200	
-----------	----------	----------	----------	------------	----------	-------------	--

40	SERIES	
M	VERSION M = standard, magnetic	
2	OPERATION 2 = double-acting, front and rear cushions 3 = double-acting, no cushion 4 = double-acting, rear cushions 5 = double-acting, front cushion 6 = double-acting, through-rod, front and rear cushions 8 = double-acting, through-rod, no cushion	PNEUMATIC SYMBOLS CD09 CD08 CD10 CD11 CD13 CD12
L	MATERIALS L = see the GENERAL DATA table on the previous page T = stainless steel AISI 420B tie-rods - stainless steel AISI 303 tie-rod nuts C = rolled stainless steel AISI 303 piston rod, stainless steel AISI 304 piston rod nut U = rolled stainless steel AISI 303 piston rod, stainless steel AISI 304 piston-rod nut, stainless steel AISI 420B tie-rods, stainless steel AISI 303 tie-rod nuts W = rolled stainless steel AISI 304 piston rod, stainless steel AISI 304 piston-rod nut, stainless steel AISI 420B tie-rods, stainless steel AISI 303 tie-rod nuts Note: the rod of cylinders with bore of 250 and 320 mm is in C40 chrome plated steel.	
160	BORE 160 = 160 mm - 200 = 200 mm - 250 = 250 mm - 320 = 320 mm	
A	TYPE OF BRACKET A = standard F = cylinder with centre trunnion	
0200	STROKE (see the table) = standard V = FKM rod seals W = all FKM seals +130°C C = PU coated cylinder. Colour: Grey* G = with brass rod scraper (chrome plated stainless steel AISI 420B rod, NBR rod seal) [∅ 250 and 320 excluded] (_ _ _) = extended piston rod _ _ _ mm Notes: the C version is available on request. For further details, contact our technical dept. The W and C versions are available for diameters 160 and 200 only.	

PNEUMATIC SYMBOLS

The pneumatic symbols which have been indicated in the CODING EXAMPLE are shown below.

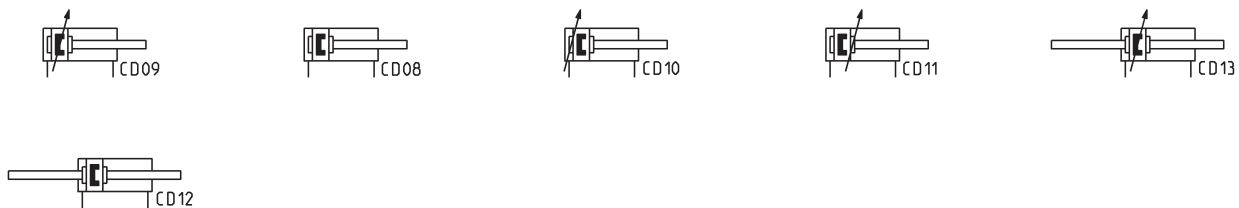

ACCESSORIES FOR SERIES 40 CYLINDERS

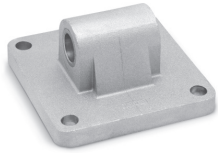

Rear trunnion, male
Mod. L



Self aligning rod
Mod. GK



Clevis pin Mod. S

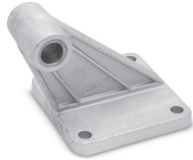

90° Swivel combination
Mod. ZS

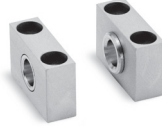

Counter bracket for
centre trunnion Mod. BF

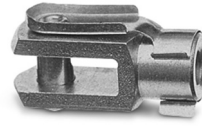

Rod fork end Mod. G

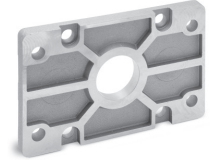

Front and rear flange
Mod. D-E



Centre trunnion Mod. F



Foot mount Mod. B



Swivel ball joint Mod. GA

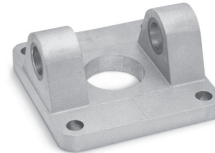

Female trunnion
Mod. C-H



Piston rod lock nut
Mod. U



All accessories are supplied separately except for piston rod lock nut Mod. U.
Details about proximity switches and their brackets can be found in the dedicated section.

Series 40 cylinders



+ = add the stroke

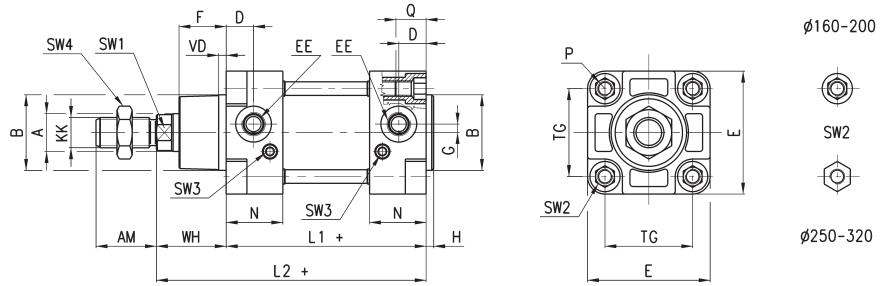

DIMENSIONS																							
∅	A	KK	B	D	G	F	AM	H	EE	WH	L1+	L2+	VD	N	P	Q	TG	E	SW1	SW2	SW3	SW4	front/rear cushion strokes
160	40	M36x2	65	25	12	53.5	72	6	G3/4	80	180	260	6	45	M16	26	140	176	36	17	4	55	29 / 36
200	40	M36x2	75	25	12	63.5	72	6	G3/4	95	180	275	6	45	M16	26	175	216	36	17	4	55	44 / 42
250	50	M42x2	90	31	12	67	84	10	G1	105	200	305	10	53	M20	30	220	270	46	36	4	65	50 / 50
320	63	M48x2	110	31	12	83	96	10	G1	120	220	340	12	55.5	M24	30	270	340	55	41	-	75	56 / 56

Series 40 cylinders - through-rod



+ = add the stroke once
++ = add the stroke twice

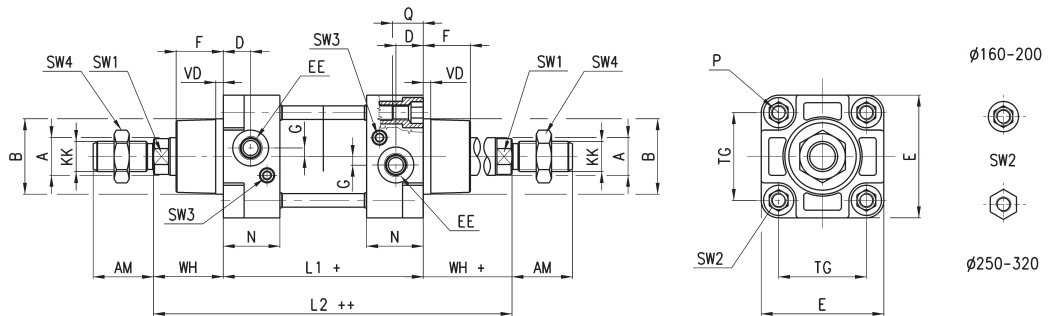

DIMENSIONS																							
∅	A	KK	B	D	G	F	AM	EE	WH	L1+	L2++	VD	N	P	Q	TG	E	SW1	SW2	SW3	SW4	front/rear cushion strokes	
160	40	M36x2	65	25	12	53.5	72	G3/4	80	180	340	6	45	M16	26	140	176	36	17	4	55	29 / 36	
200	40	M36x2	75	25	12	63.5	72	G3/4	95	180	370	6	45	M16	26	175	216	36	17	4	55	44 / 42	
250	50	M42x2	90	31	12	67	84	G1	105	200	410	10	53	M20	30	220	270	46	36	4	65	50 / 50	
320	63	M48x2	110	31	12	83	96	G1	120	220	460	12	55.5	M24	30	270	340	55	41	-	75	56 / 56	

Series 40 cylinders with centre trunnion Mod. F



+ = add the stroke
 + 1/2 = add the stroke half

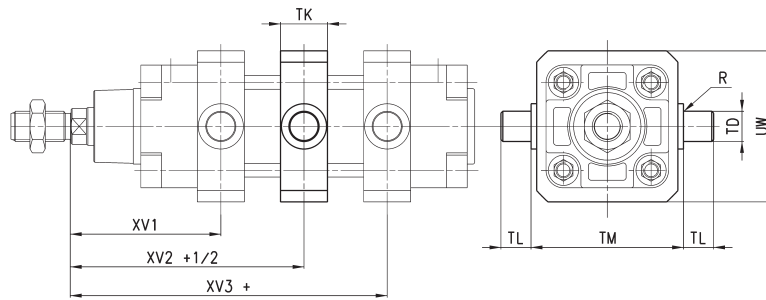

DIMENSIONS										
∅	XV1	XV2+ 1/2	XV3+	TM	TK	TD	TL	UW	R	NOTE
160	145	170	195	200	40	32	32	190	2	
200	160	185	210	250	40	32	32	240	2	
250	185	205	225	320	50	40	40	300	-	mounting with 4 threaded tie-rods
320	210.5	230	249.5	400	70	50	50	400	-	mounting with 4 threaded tie-rods

SERIES 40 CYLINDERS

Foot mount Mod. B



Supplied with:
2x feet in black-painted steel
(cataphoresis)
4x white zinc plating screws

For diameters 250 and 320 white zinc plating

+ = add the stroke

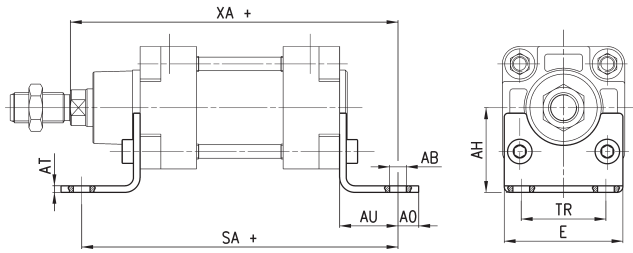

DIMENSIONS										
Mod.	∅	AT	SA+	XA+	TR	E	∅AB	AH	AO	AU
B-41-160	160	10	300	320	115	175	18.5	115	25	60
B-41-200	200	12	320	345	135	238	24	135	35	70
B-41-250	250	14	350	380	165	270	26	165	25	75
B-41-320	320	20	390	425	200	353	35	200	45	85

Front and rear flange Mod. D-E

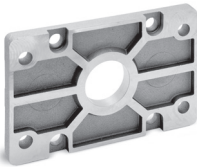

Supplied with:
1x flange
4x screws

+ = add the stroke

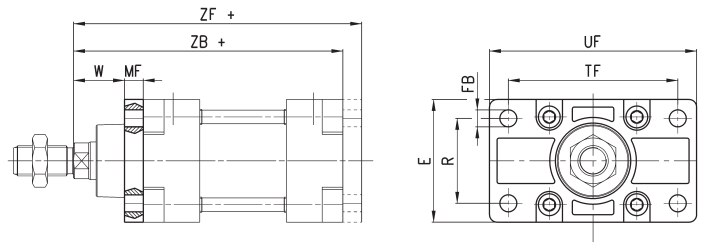

DIMENSIONS											
Mod.	∅	W	MF	ZB+	TF	R	UF	E	∅FB	ZF+	Material
D-E-41-160	160	60	20	260	230	115	276	175	18	280	aluminium
D-E-41-200	200	70	25	275	270	135	312	215	22	300	aluminium
D-E-41-250	250	80	25	305	330	165	400	285	26	330	zinc-plated steel
D-E-41-320	320	90	30	340	400	200	470	334	33	370	stainless steel 304

Front and rear female trunnion Mod. C-H

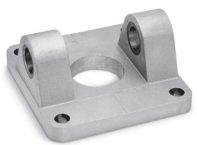

Supplied with:
1x female trunnion in Aluminium
4x screws

+ = add the stroke

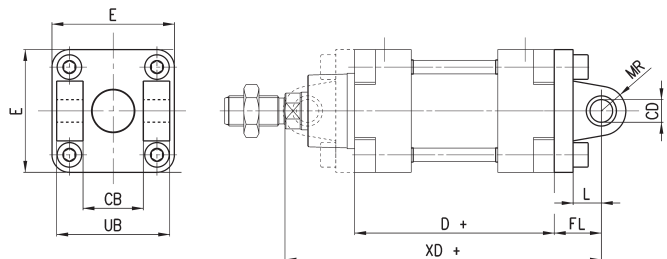

DIMENSIONS										
Mod.	∅	∅CD	L	FL	D+	XD+	MR	E	CB	UB
C-H-41-160	160	30	35	55	180	315	30	175	90	170
C-H-41-200	200	30	35	60	180	335	30	215	90	170
C-H-41-250	250	40	45	70	200	375	40	270	110	200
C-H-41-320	320	45	50	80	220	420	45	350	120	220

Rear male trunnion Mod. L

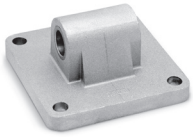

Supplied with:
1x male trunnion in Aluminium *
4x screws

* For \varnothing 320 black-painted steel (cataphoresis)

+ = add the stroke

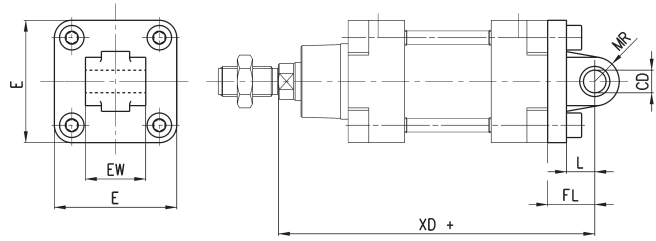

DIMENSIONS								
Mod.	\varnothing	\varnothing CD	L	FL	XD+	MR	E	EW
L-41-160	160	30	35	55	315	30	175	90
L-41-200	200	30	35	60	335	30	215	90
L-41-250	250	40	45	70	375	40	270	110
L-41-320	320	45	50	80	420	45	350	110

Centre trunnion Mod. F



Material:
- zinc-plated steel (\varnothing 160 and 200)
- painted cast iron (\varnothing 250 and 320)

+ = add the stroke

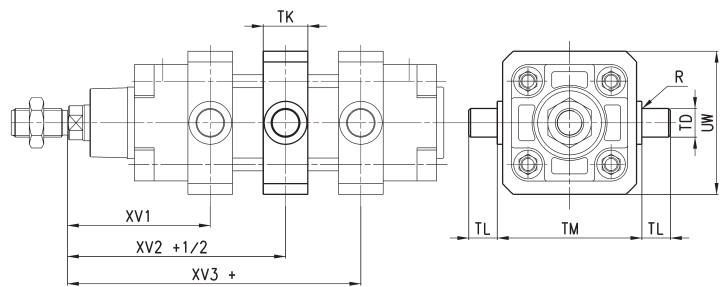

DIMENSIONS											
Mod.	\varnothing	XV1	XV + 1/2	XV3 +	TM	TK	\varnothing TD	TL	UW	R	NOTE
F-160	160	145	170	195	200	40	32	32	190	2	
F-200	200	160	185	210	250	40	32	32	240	2	
F-250	250	185	205	225	320	50	40	40	296	-	mounting with 4 threaded tie-rods
F-320	320	210,5	230	249,5	400	70	50	50	400	-	mounting with 4 threaded tie-rods

90° Swivel combination Mod. ZS*

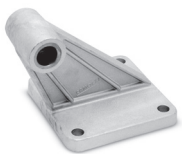

* not according to standard

Supplied with:
1x 45° swivel combination in Aluminium

+ = add the stroke

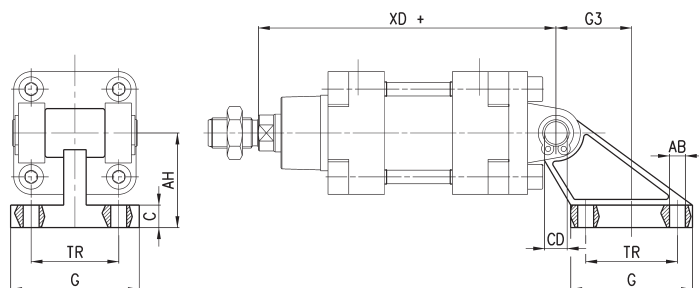

DIMENSIONS									
Mod.	\varnothing	TR	\varnothing AB	AH	C	G	\varnothing CD	XD +	G3
ZS-160	160	140	18	140	20	180	30	315	105
ZS-200	200	175	18	140	25	220	30	335	125

Swivel combination Mod. C+L+S

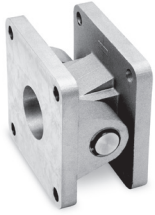

+ = add the stroke

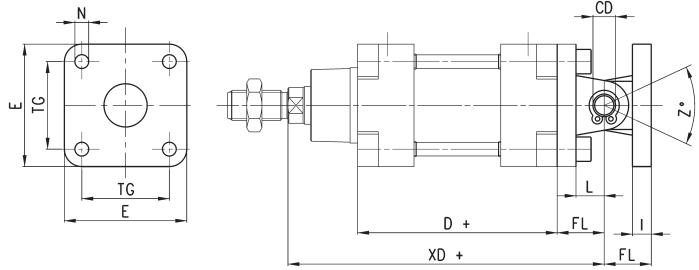

DIMENSIONS											
Mod.	∅	E	TG	∅N	D+	XD+	∅CD	L	FL	I	Z ² (max)
C+L+S	160	175	140	17	180	315	30	35	55	20	25
C+L+S	200	215	175	17	180	335	30	35	60	25	20
C+L+S	250	270	220	22	200	375	40	45	70	25	33
C+L+S	320	350	270	30	220	420	40	50	80	30	30

Counter bracket for centre trunnion Mod. BF



Supplied with 2 supports
in Aluminium

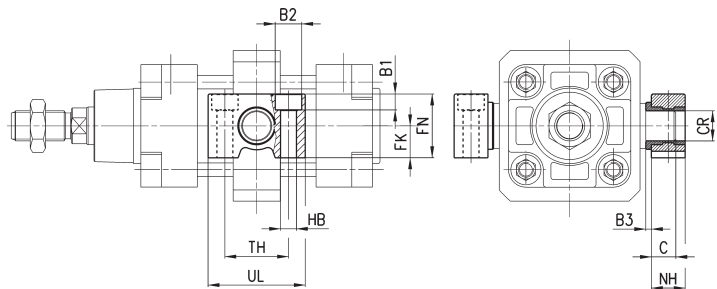

DIMENSIONS												
Mod.	∅	∅CR	NH	C	B3	TH	UL	FK	FN	B1	∅B2	∅HB
BF-160-200	160-200	32	35	17,5	4	60	92	30	60	16	26	18

Rod fork end Mod. G

ISO 8140

Material:
- zinc-plated steel

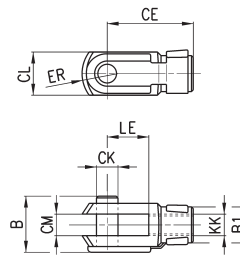

DIMENSIONS										
Mod.	∅	∅CK	LE	CM	CL	ER	CE	KK	B	∅B1
G-160-200	160-200	35	72	35	70	44	144	M36x2	92	60
G-250	250	40	84	40	85	-	168	M42x2	96	70
G-320	320	50	96	50	90	73	192	M48x2	120	80

Swivel ball joint Mod. GA

ISO 8139

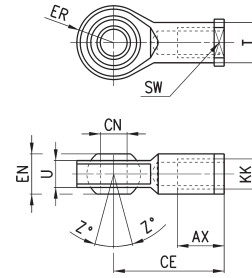

DIMENSIONS											
Mod.	∅	∅CN	U	EN	ER	AX	CE	KK	∅T	Z	SW
GA-160-200	160-200	35	28	43	40	56	125	M36x2	46	6	50
GA-250	250	40	33	49	-	60	142	M42x2	55	17	55
GA-320	320	50	45	60	58.5	65	160	M48x2	65	12	65

Clevis pin Mod. S

Supplied with:
1x centering pin
2x seeger in steel

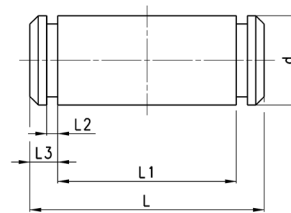

DIMENSIONS							
Mod.	∅	d	L	L1	L2	L3	
S-160-200	160-200	30	180.5	172	1.6	4.25	stainless steel 303
S-250	250	40	210	202	1.85	4.5	zinc-plated steel
S-320	320	45	236	222	1.85	7	zinc-plated steel

Piston rod lock nut Mod. U

ISO 4035
Material: zinc-plated steel

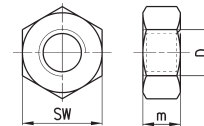

DIMENSIONS				
Mod.	∅	D	m	SW
U-160-200	160-200	M36x2	14	55
U-250	250	M42x2	16	65
U-320	320	M48x2	24	75

Self aligning rod Mod. GK

Material: zama and zinc-plated steel.

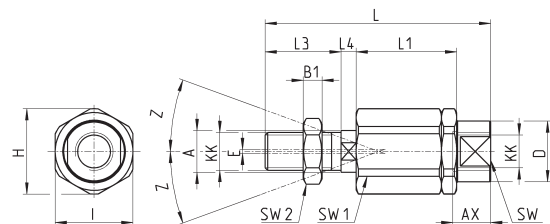

DIMENSIONS																	
Mod.	∅	KK	L	L1	L3	L4	∅A	∅D	H	I	SW	SW1	SW2	B1	AX	Z	E
GK-160-200	160-200	M36x2	190	77	72	15.5	39	57	75	70	54	32	55	14	68	4	2