

# Series 27 roundline cylinders

Double-acting, magnetic  
ø 20, 25, 32, 40, 50, 63 mm

SERIES 27 ROUNDLINE CYLINDERS



- » Reduced dimensions
- » Different mounting options
- » Perfect alignment, perfect linearity

Series 27 has been designed to reduce the cylinders sizes as much as possible. These cylinders have been constructed with clean lines using stainless steel for both the tube and the rod and Aluminium for the end-blocks.

The choice of material and other design features have allowed to create a range of versatile and reliable cylinders. The precise method of securing the tube to the end block ensures that all the parts are perfectly aligned. Mechanical cushioning has been fitted on these cylinders in order to reduce noise produced by the piston impact on the end-blocks. Cylinders Series 27 are suitable for assembling with magnetic sensors. Various mounting bracket accessories enable the cylinders to be fitted to suit the requirements of a particular application.

## GENERAL DATA

Type of construction	flanged
Operation	double acting
Materials	rod: Ø20 - 25 stainless steel AISI 303 - Ø32 ÷ 63 stainless steel AISI 420B tube: INOX AISI 304 piston and rod seals = PU
Mounting	feet - trunnion - steel bar - pins
Strokes min-max	all diameters 10 - 1000 mm
Bores	ø 20, 25, 32, 40, 50, 63
Operating temperature	0°C ÷ 80°C (with dry air - 20°C)
Operating pressure	1 ÷ 10 bar
Speed	10 ÷ 1000 mm/sec (no load)
Fluid	filtered air, without lubrication. If lubricated air is used, it is recommended to use oil ISOVG32. Once applied the lubrication should never be interrupted.

**STANDARD STROKES FOR DOUBLE-ACTING CYLINDERS SERIES 27**

Mod. 27M and 27T (∅ 20 ÷ 40) and Mod. 27U (∅ 20 ÷ 63)

STANDARD STROKES														
∅	10	25	40	50	80	100	125	160	200	250	300	320	400	500
20	■	■	■	■	■	■	■	■	■	■	■	■	■	■
25	■	■	■	■	■	■	■	■	■	■	■	■	■	■
32	■	■	■	■	■	■	■	■	■	■	■	■	■	■
40	■	■	■	■	■	■	■	■	■	■	■	■	■	■
50	■	■	■	■	■	■	■	■	■	■	■	■	■	■
63	■	■	■	■	■	■	■	■	■	■	■	■	■	■

**CODING EXAMPLE**

<b>27</b>	<b>M</b>	<b>2</b>	<b>A</b>	<b>20</b>	<b>A</b>	<b>0050</b>
-----------	----------	----------	----------	-----------	----------	-------------

<b>27</b>	SERIES
<b>M</b>	VERSION M = rear endblock with trunnion and upper round port for ∅ 20-25-32-40 T = rear endblock with rear round port for ∅ 20-25-32-40 U = rear endblock with upper round port for ∅ 20-25-32-40-50-63
<b>2</b>	OPERATION 2 = double-acting  PNEUMATIC SYMBOL CD08
<b>A</b>	MATERIALS A = rolled stainless steel rod - stainless steel tube
<b>20</b>	BORE 20 = 20 mm - 25 = 25 mm - 32 = 32 mm - 40 = 40 mm - 50 = 50 mm - 63 = 63 mm
<b>A</b>	TYPE OF DESIGN A = standard
<b>0050</b>	STROKE (see the table)

SERIES 27 ROUNDLINE CYLINDERS

**PNEUMATIC SYMBOLS**

The pneumatic symbols which have been indicated in the CODING EXAMPLE are shown below.

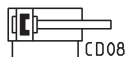

**ACCESSORIES FOR MAGNETIC CYLINDERS SERIES 27**

SERIES 27 ROUNDLINE CYLINDERS



Coupling piece  
Mod. GKF



Self aligning rod  
Mod. GK



Threaded trunnion pin  
Mod. T



Piston rod socket joint  
Mod. GY



Swivel ball joint Mod. GA



Foot mount Mod. B



Foot mount Mod. B



Nose nut Mod. V



Rear trunnion bracket  
Mod. I



Piston rod lock nut  
Mod. U

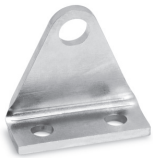

Rear trunnion bracket  
Mod. I

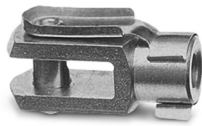

Rod fork end Mod. G

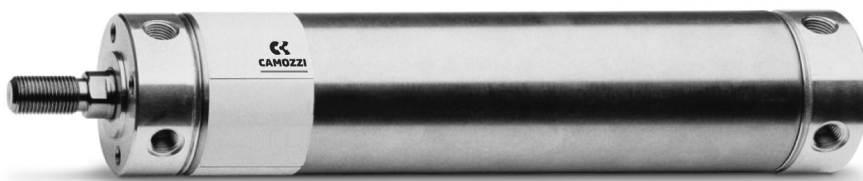

All accessories are supplied separately.

**Cylinders Series 27 (Ø 20, 25, 32, 40)**

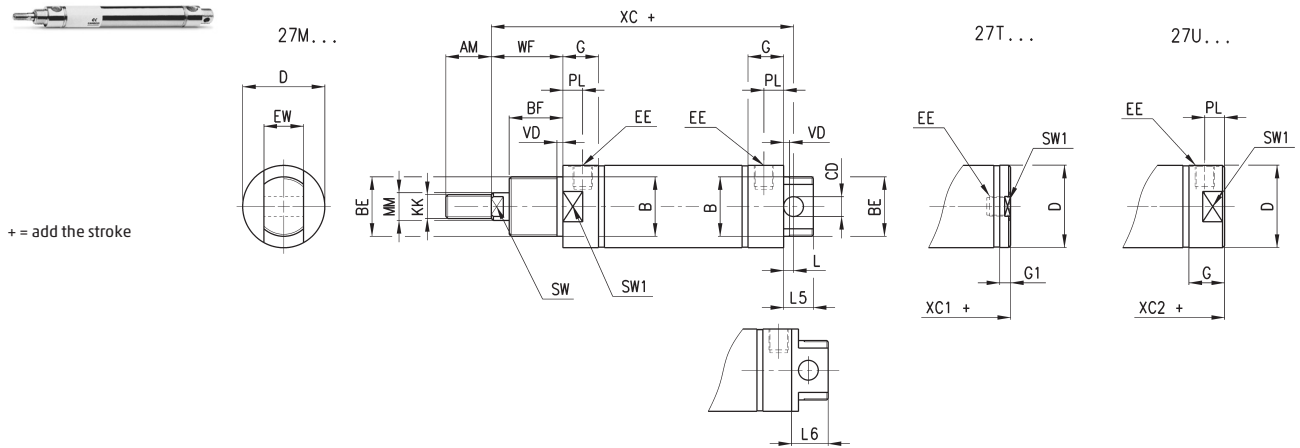

DIMENSIONS																							
Ø	AM	$\varnothing$ B	BF	BE	$\varnothing$ CD <sup>(109)</sup>	$\varnothing$ D	EE	EW	G	G1	KK	L	L6	MM <sup>(109)</sup>	L5	PL	SW	VD	WF	XC+	XC1+	XC2+	SW1
20	14	16	12	M16x1,5	6	21,5	G1\8	12	15,5	8	M8x1,25	7	-	8	13	9	7	3	17	77	62,5	70,8	19
25	16	18	12	M18x1,5	8	26,5	G1\8	14	15,5	8	M10x1,25	9	-	10	17	9	9	3	16,5	78,5	62	69,5	24
32	22	22	15	M22x1,5	8	33,5	G1\8	16	17,5	5,5	M10x1,25	7	20	12	15	9	10	3	23	93	74	86	30
40	23	30	15	M30x1,5	10	41,5	G1\8	20	18	5,5	M12x1,25	5	24	16	15	10	13	3	24	96	78,5	91	38

**Cylinders Series 27 (Ø 50, 63)**

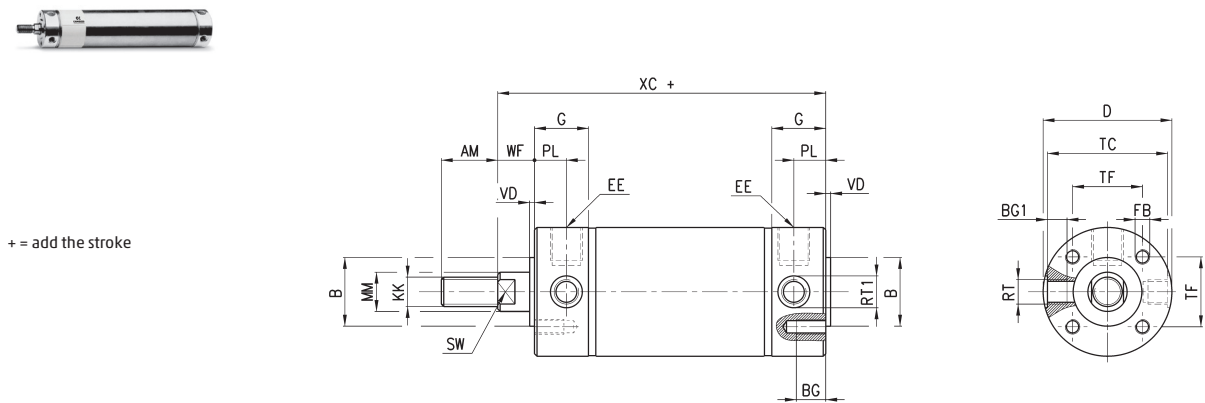

DIMENSIONS																			
Ø	AM	$\varnothing$ B	BG	BG1	$\varnothing$ D	EE	FB	G	KK	$\varnothing$ MM <sup>(109)</sup>	PL	RT	$\varnothing$ RT1	SW	TC	TF	VD	WF	XC+
50	23	28	12	8	52,5	G1\4	M6	22	M12x1,25	16	13	M10x1	12	13	49	28,5	2	13	97
63	30	35	12	9,5	65,5	G1\4	M8	22	M16x1,5	20	13	M12x1,5	14	17	62	35,5	2	13	99

### Foot mount Mod. B

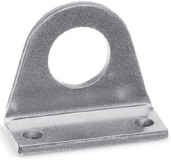

Material: zinc-plated steel

Supplied with:  
1x foot  
1x front end cap nut mod. V

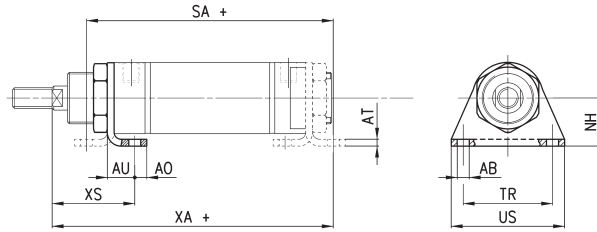

+ = add the stroke

DIMENSIONS											
Mod.	∅	∅AB	AO	AT	AU	NH	SA+	TR	US	XA+	XS
B-27-20	20	5,5	6	3	13	20	79	32	42	83	27
B-27-25	25	6,6	8	3	12,5	22	78	38	49	82	26
B-27-32	32	6,6	8	4	16	25	95	40	54	102	35
B-27-40	40	7	7	4	16	28	99	52	66	107	36

### Foot mount Mod. B



Material: zinc-plated steel

Supplied with:  
2x feet  
4x screws

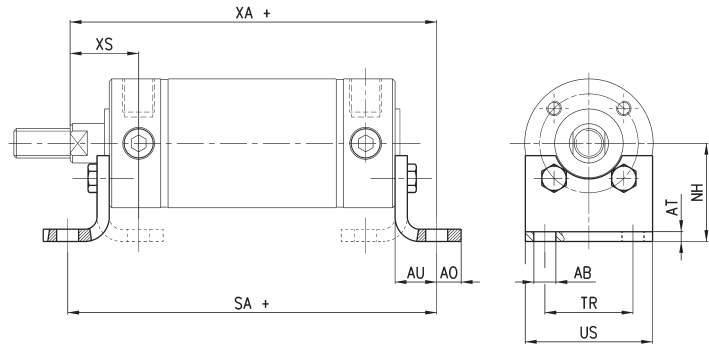

+ = add the stroke

DIMENSIONS											
Mod.	∅	∅AB	AO	AT	AU	NH	SA+	TR	US	XA+	XS
B-27-50	50	9	10	4	17	40	118	36	52	114	26
B-27-63	63	9	10	5	19	47	124	45	61	118	27

### Threaded trunnion pin Mod. T



Material: stainless steel

Supplied with:  
2x pins

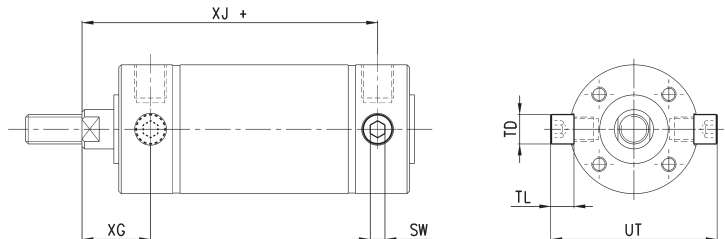

+ = add the stroke

DIMENSIONS							
Mod.	∅	SW	TD <sup>99</sup>	TL	UT	XG	XJ+
T-27-50	50	6	12	9,5	68	26	84
T-27-63	63	6	14	11	84	26	86

### Rear trunnion bracket Mod. I (Ø 20, 25, 32, 40)

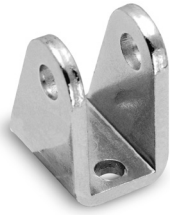

Material: zinc-plated steel

Supplied with:  
1x female hinge  
1x pin  
2x Seeger

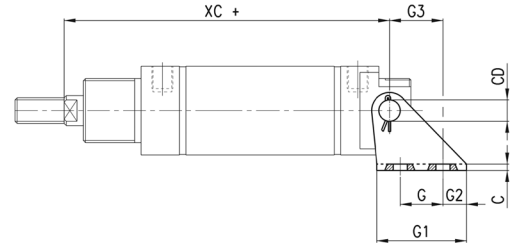
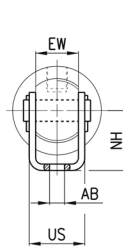

+ = add the stroke

DIMENSIONS													
Mod.	Ø	G	G1	G2	G3	C	XC+	øAB	US	NH	øCD	EW	
I-27-20	20	15	30	8	18,5	1,5	77	5,5	15	20	6	12	
I-27-25	25	15	33	9	20	2	78,5	6,6	18	22	8	14	
I-27-32	32	15	35	10	20	2	93	6,6	20,5	25	8	16	
I-27-40	40	20	42	11	25	3	96	7	26	28	10	20	

### Rear trunnion bracket Mod. I



Material: zinc-plated steel

Supplied with:  
2x pins  
2x feet

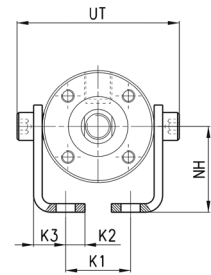
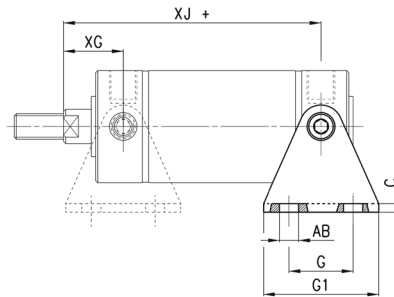

+ = add the stroke

DIMENSIONS													
Mod.	Ø	G	G1	C	XJ+	XG	øAB	K1	K1	K2	K3	NH	UT
I-27-50	50	30	54	4	84	26	9	9	30,5	9	15	40	68
I-27-63	63	40	64	5	86	26	9	9	40,5	9	17,5	47	84

### Rod fork end Mod. G



Material: zinc-plated steel  
ISO 8140

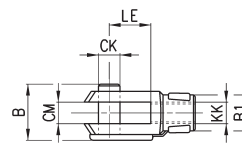
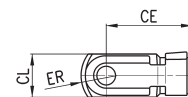

DIMENSIONS										
Mod.	Ø	øCK	LE	CM	CL	ER	CE	KK	B	øB1
G-20	20	8	16	8	16	10	32	M8x1,25	22	14
G-25-32	25-32	10	20	10	20	12	40	M10x1,25	26	18
G-40	40-50	12	24	12	24	14	48	M12x1,25	32	20
G-50-63	63	16	32	16	32	19	64	M16x1,5	40	26

### Swivel ball joint Mod. GA



Material: zinc-plated steel  
ISO 8139

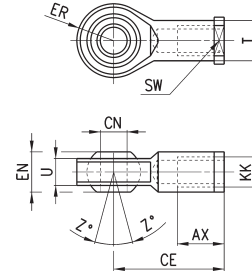

DIMENSIONS											
Mod.	∅	$\phi$ CN <sup>(H7)</sup>	U	EN	ER	AX	CE	KK	$\phi$ T	Z	SW
GA-20	20	8	9	12	12	16	36	M8x1,25	12,5	6,5	14
GA-32	25-32	10	10,5	14	14	20	43	M10x1,25	15	6,5	17
GA-40	40-50	12	12	16	16	22	50	M12x1,25	17,5	6,5	19
GA-50-63	63	16	15	21	21	28	64	M16x1,5	22	7,5	22

### Piston rod socket joint Mod. GY



Material: zama and zinc-plated steel

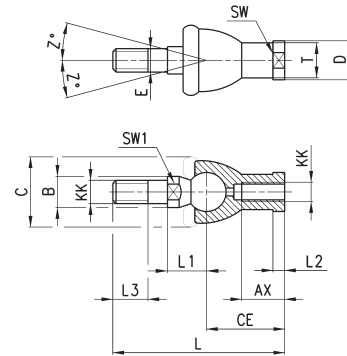

DIMENSIONS																
Mod.	∅	KK	L	CE	L2	AX	E	$\phi$ B	$\phi$ C	T	D	L1	L3	SW1	Z	
GY-20	20	M8x1,25	65	32	5	16	8	12	24	12,5	16	16	12	10	14	15
GY-32	25-32	M10x1,25	74	35	6,5	18	10	14	28	15	19	19,5	15	11	17	15
GY-40	40-50	M12x1,25	84	40	6,5	20	12	19	32	17,5	22	21	17	17	19	15
GY-50-63	63	M16x1,5	112	50	8	27	16	22	40	22	27	27,5	23	19	22	11

### Piston rod lock nut Mod. U



Material: zinc-plated steel  
ISO 4035

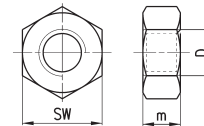

DIMENSIONS				
Mod.	∅	D	m	SW
U-20	20	M8x1,25	5	13
U-25-32	20-32	M10x1,25	6	17
U-40	40-50	M12x1,25	7	19
U-50-63	63	M16x1,5	8	24

### Nose nut Mod. V



ISO 4035  
V-27-25 / V-42-32 not according standard.  
Material: zinc-plated steel

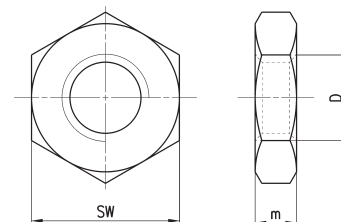

DIMENSIONS				
Mod.	∅	D	m	SW
V-12-16	20	M16x1,5	8	24
V-27-25	25	M18x1,5	5	24
V-20-25	32	M22x1,5	10	32
V-42-32	40	M30x1,5	8	-

### Self aligning rod Mod. GK

Material: zinc-plated steel

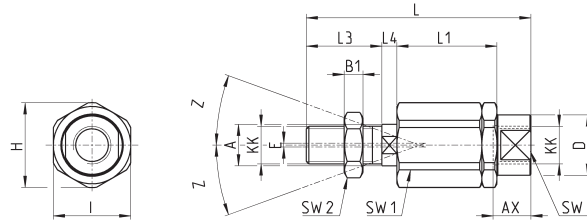

DIMENSIONS																	
Mod.	∅	KK	L	L1	L3	L4	∅ A	∅ D	H	I	SW	SW1	SW2	B1	AX	Z	E
GK-20	20	M8x1,25	57	26	21	5	8	12,5	19	17	11	7	13	4	16	4	2
GK-25-32	25-32	M10x1,25	71,5	35	20	7,5	14	22	32	30	19	12	17	5	22	4	2
GK-40	40	M12x1,25	75,5	35	24	7,5	14	22	32	30	19	12	19	6	22	4	2
GK-50-63	50-63	M16x1,5	104	53	32	10	22	32	45	41	27	20	24	8	30	3	2

### Coupling piece Mod. GKF

Material: zinc-plated steel

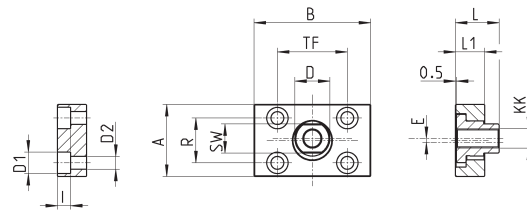
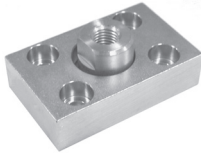

DIMENSIONS														
Mod.	∅	KK	A	B	R	TF	L	L1	I	∅ D	∅ D1	∅ D2	SW	E
GKF-20	20	M8x1,25	30	35	20	25	22,5	10	-	14	5,5	-	13	1,5
GKF-25-32	25-32	M10x1,25	37	60	23	36	22,5	15	6,8	18	11	6,6	15	2
GKF-40	40	M12x1,25	56	60	38	42	22,5	15	9	20	15	9	15	2,5
GKF-50-63	50-63	M16x1,5	80	80	58	58	26,5	15	10,5	25	18	11	22	2,5